

RUA POMERANOS (SC-110)

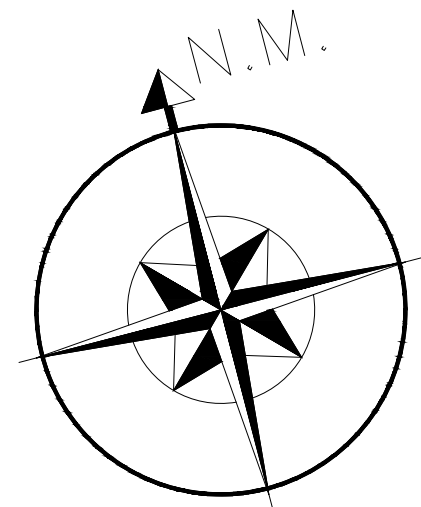

RUA FREDERICO SCHUMANN

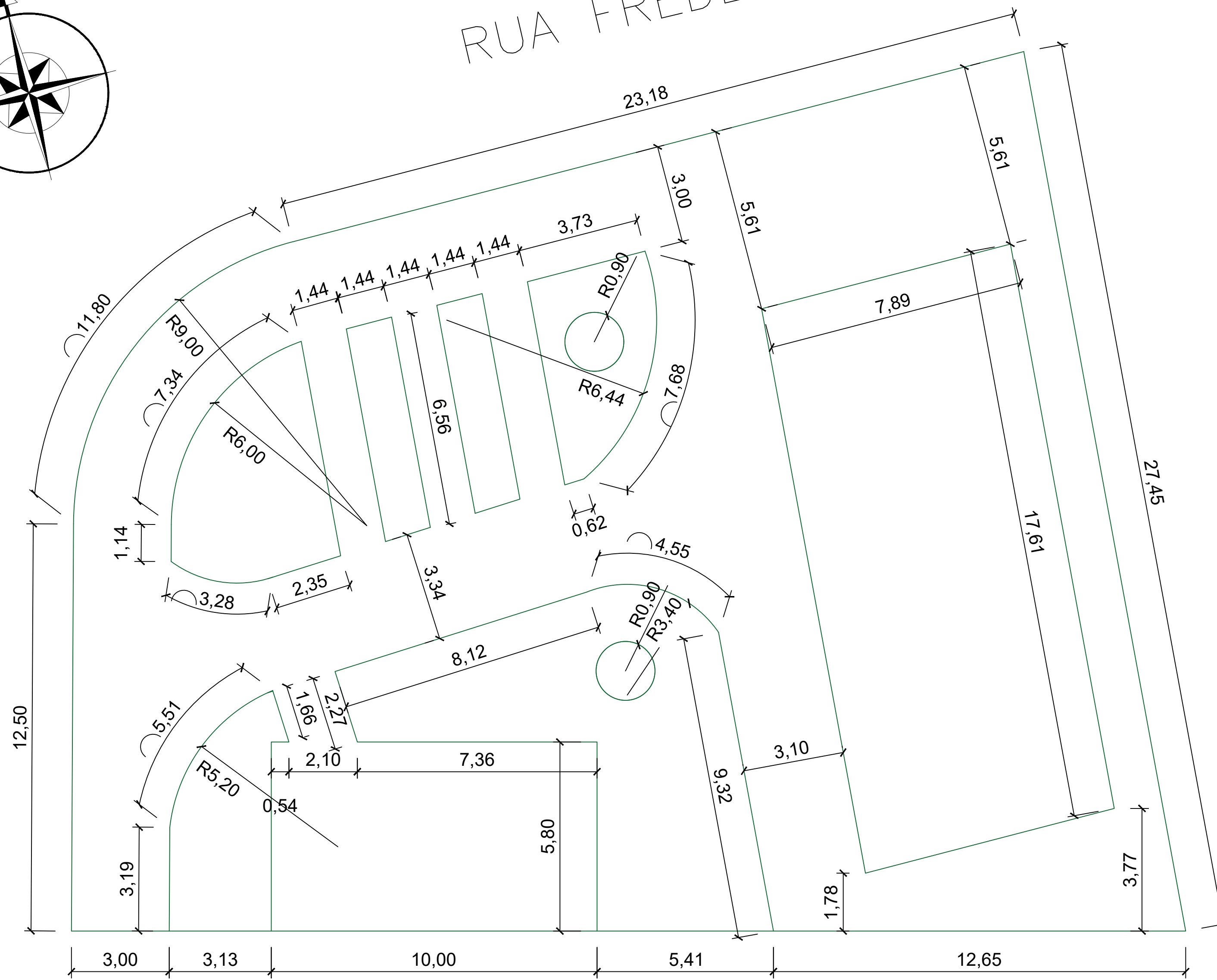

MAPA POLÍTICO DE SANTA CATARINA

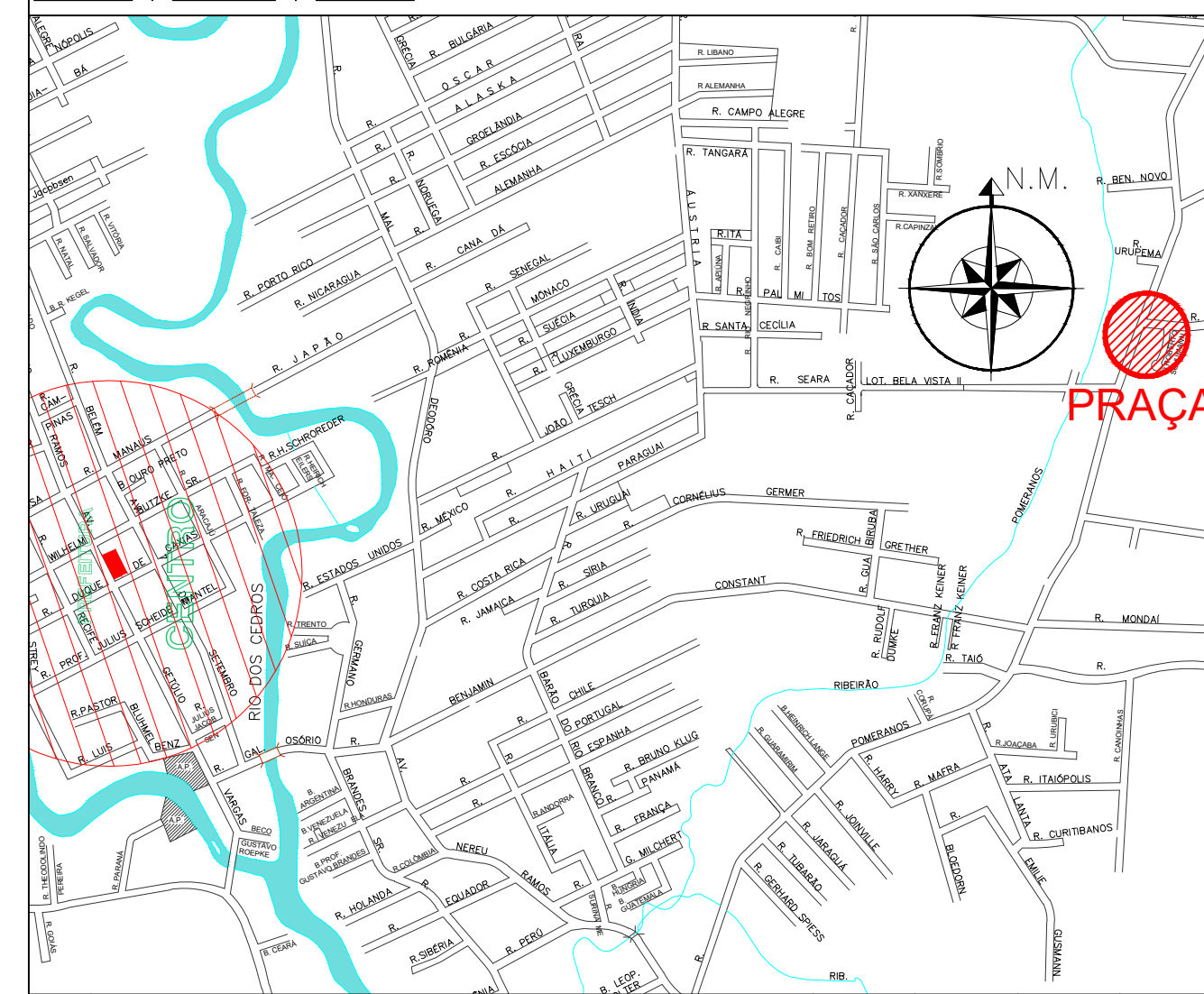
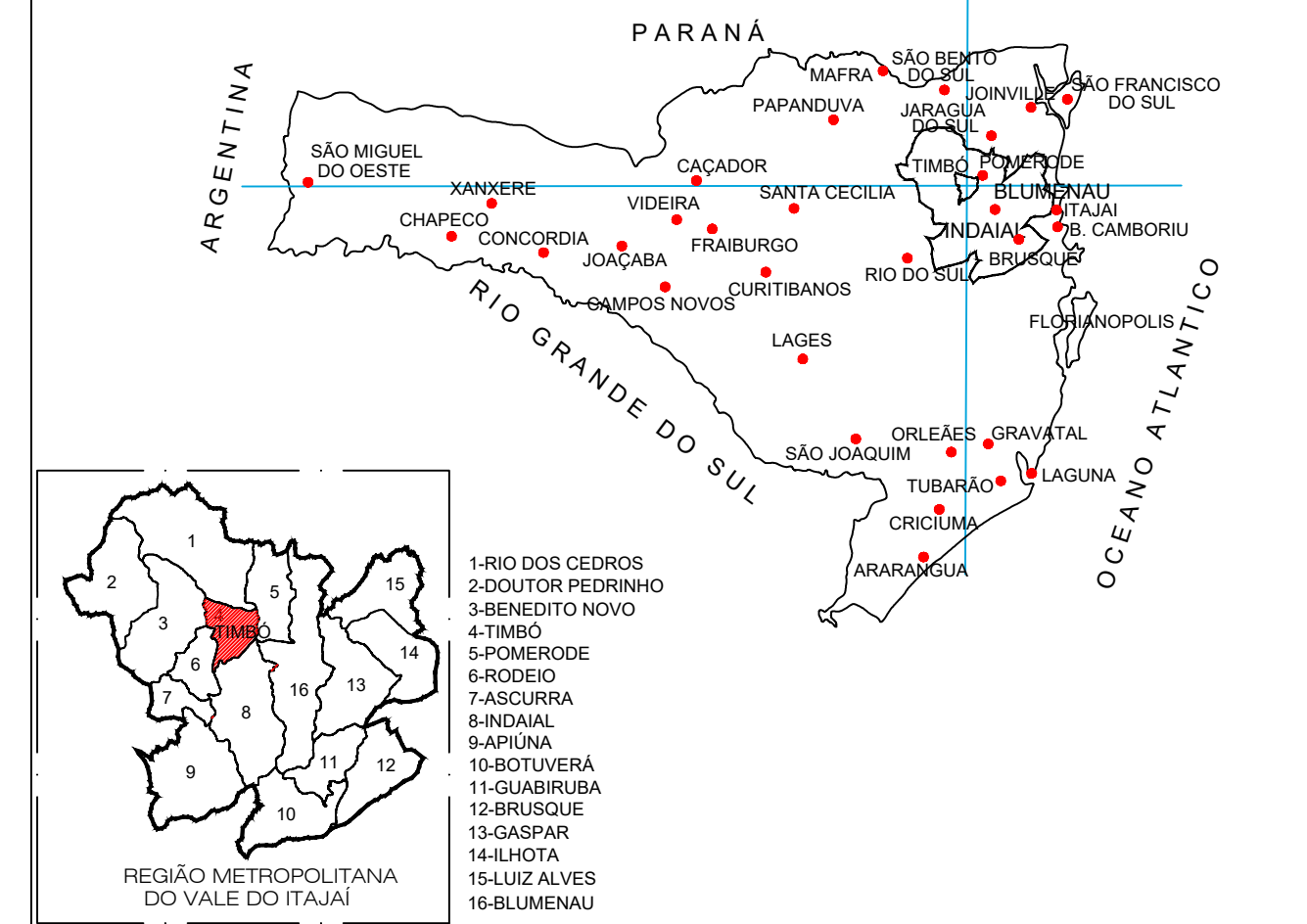

01	Emissão Inicial	06/2022		
REV.	DESCRIÇÃO	DATA	DESENHO	VERIFICADO APROVADO

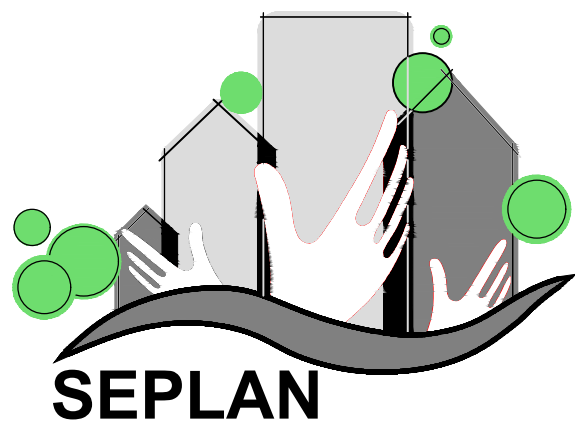

**PREFEITURA DE TIMBÓ**

SECRETARIA MUNICIPAL DE PLANEJAMENTO

Obra:	PRAÇA DA SAÚDE Bairro Pomeranos
Endereço:	RUA POMERANOS X RUA FREDERICO SCHUMANN
Projeto:	<b>PROJETO GEOMÉTRICO</b>
Resp. Técnico Projeto:	



Data:	Escala:	Área:	Prancha:
SET/2023	1 / 100		<b>GEO. 01/01</b>

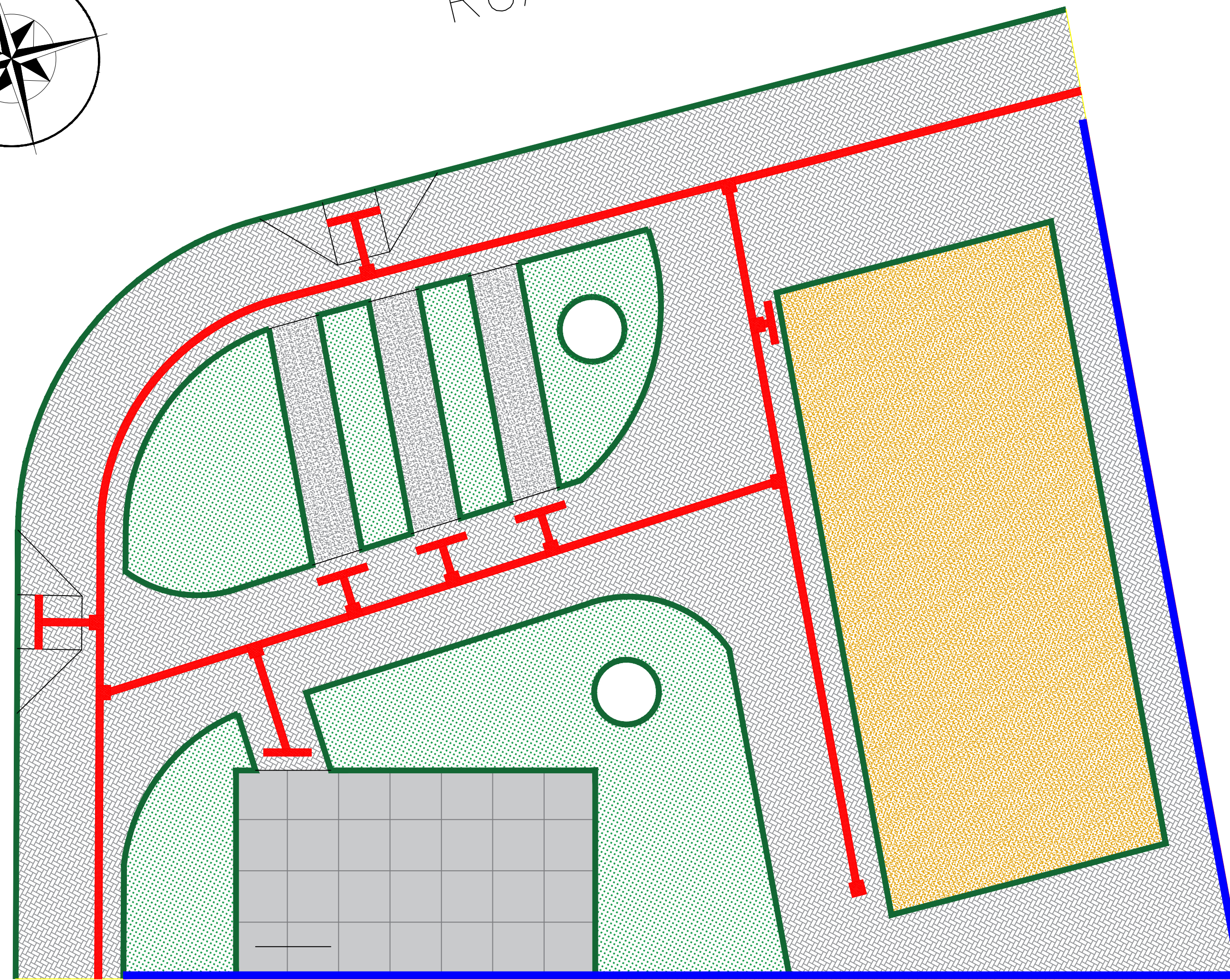
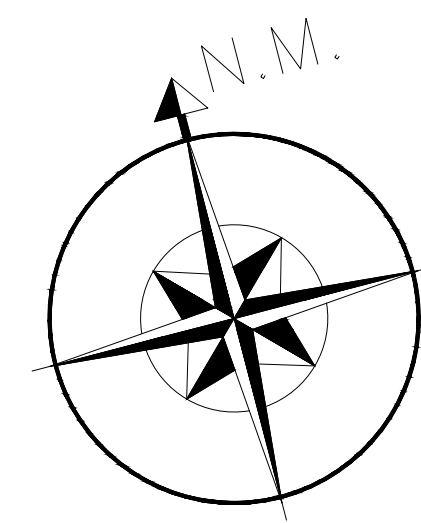

RUA POMERANOS (SC)

RUA FREDERICO SCHUMANN

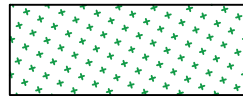
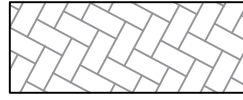

-  GRAMA BATATAIS EM PLACAS
-  PISO EM CONCRETO - E:10CM
-  PAVIMENTAÇÃO EM PAVER 10X20CM - E:6CM
-  PISO TÁTIL - ALERTA
-  PISO TÁTIL - DIRECIONAL
-  AREIA FINA
-  MEIO-FIO 100X15X13X30 CM
-  PISO EMBORRACHADO

01	Emissão Inicial	06/2022			
REV.	DESCRIÇÃO	DATA	DESENHO	VERIFICADO	APROVADO

**DETALHE 01 - Rampa de acessibilidade**

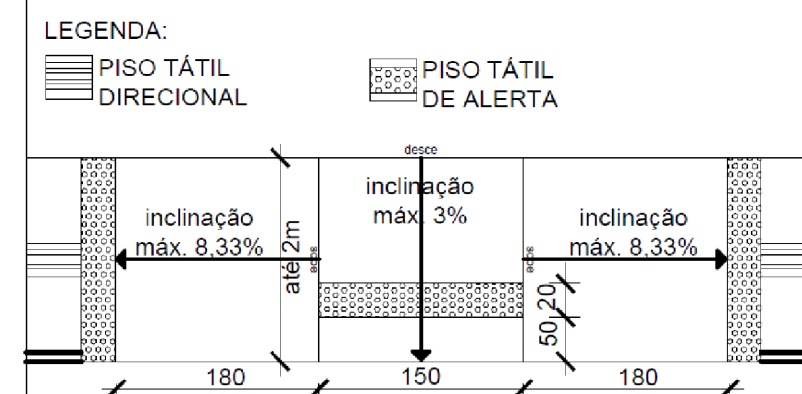

**DETALHE 02 - Rampa de acessibilidade**

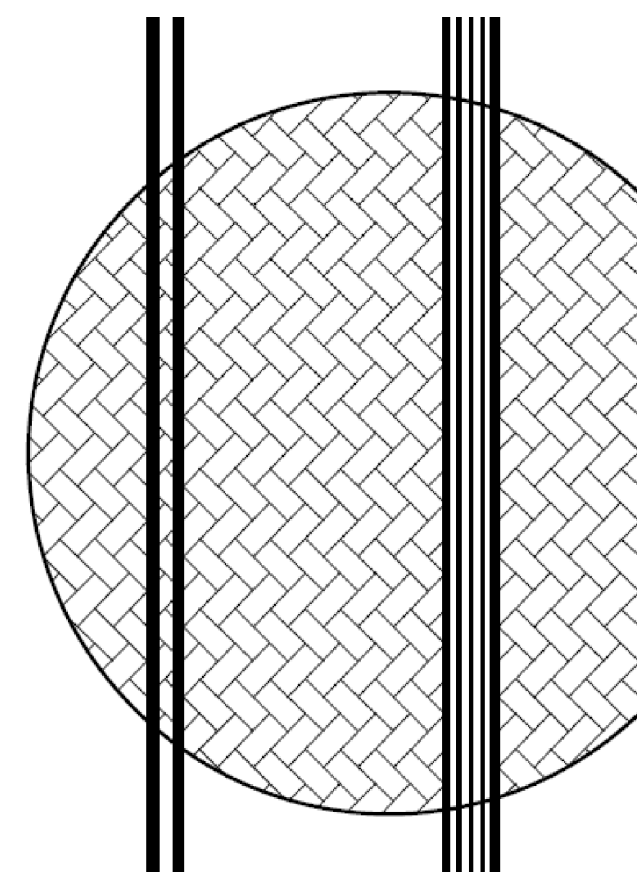
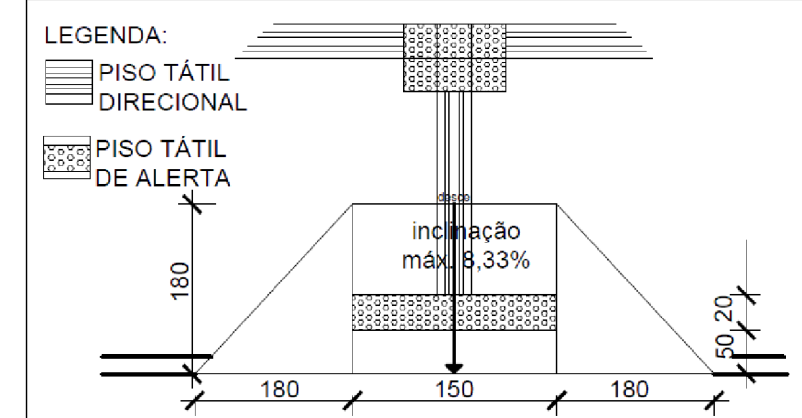

COLOCAÇÃO TIPO  
ESCAMA DE PEIXE

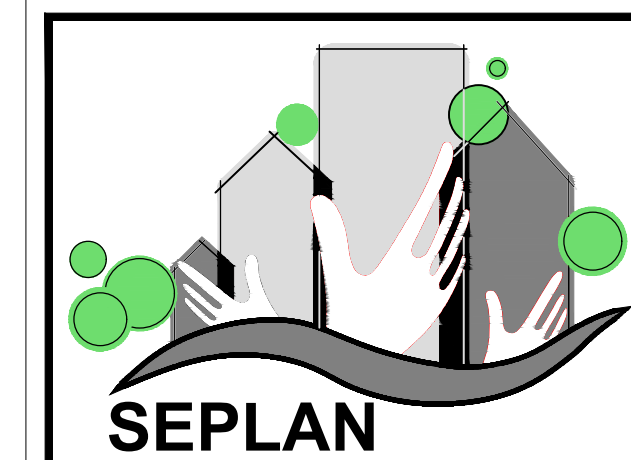

**PREFEITURA  
DE TIMBÓ**

**SECRETARIA MUNICIPAL  
DE PLANEJAMENTO**

Obra: **PRAÇA DA SAÚDE**  
Bairro Pomeranos

Endereço: **RUA POMERANOS X RUA FREDERICO SCHUMANN**

Projeto: **PROJETO URBANÍSTICO - ACESSIBILIDADE**

Resp. Técnico Projeto:

Data: SET/2023	Escala: 1 / 100	Área:	Prancha: <b>URB. 01/01</b>
-------------------	--------------------	-------	-------------------------------



RUA POMERAN

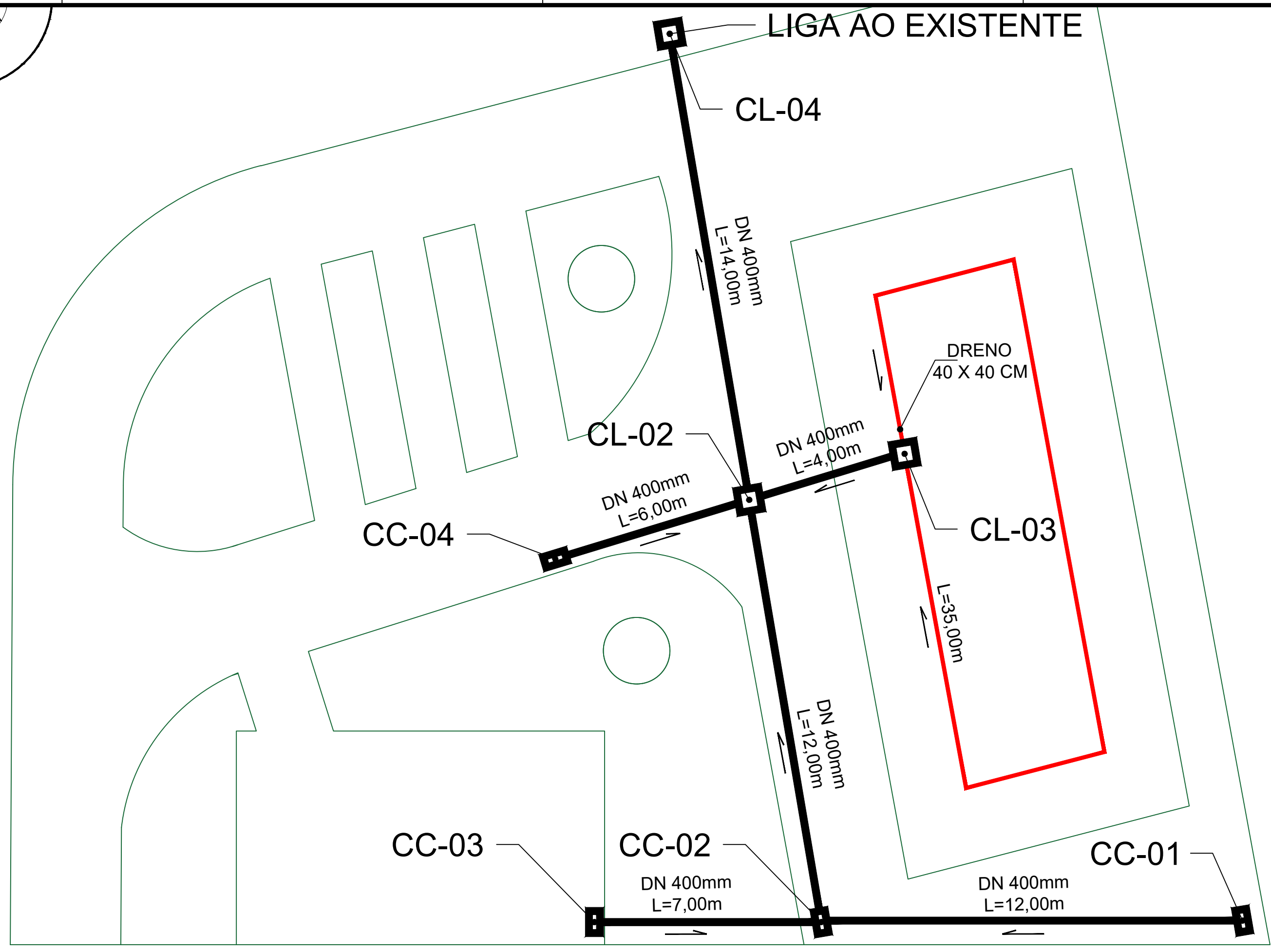
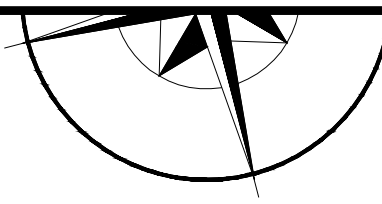

CAIXA COLETORA COM GRELHA DE CONCRETO (BOCA DE LOBO)

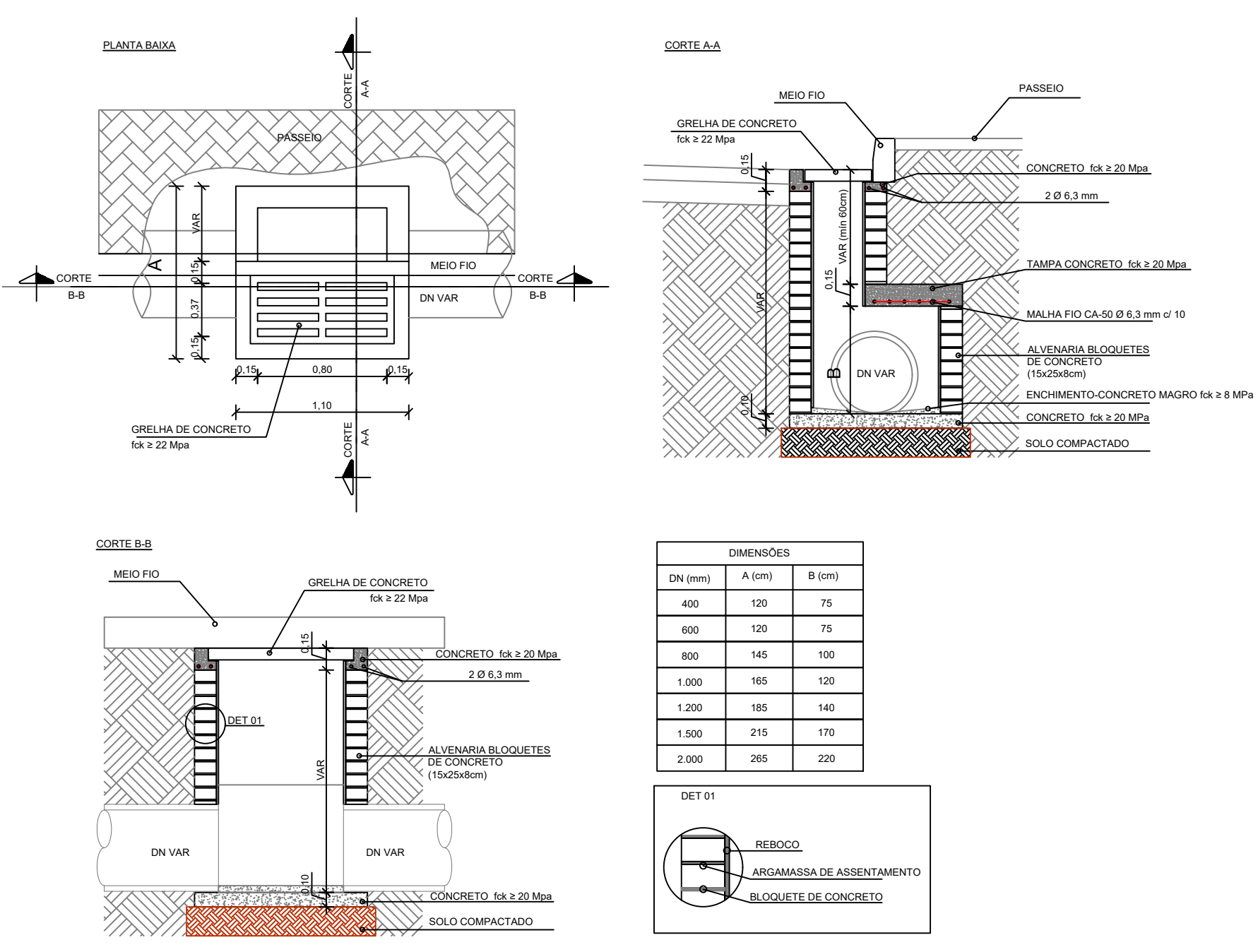

DIMENSÕES

DN (mm)	A (cm)	B (cm)
400	120	75
600	120	75
800	145	100
1.000	165	120
1.200	185	140
1.500	215	170
2.000	265	220

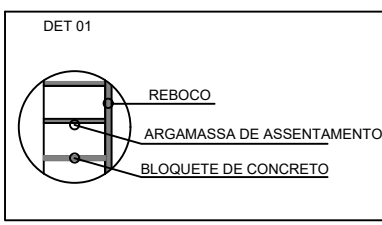

CAIXA DE LIGAÇÃO COM INSPEÇÃO E GUIA CHAPÉU

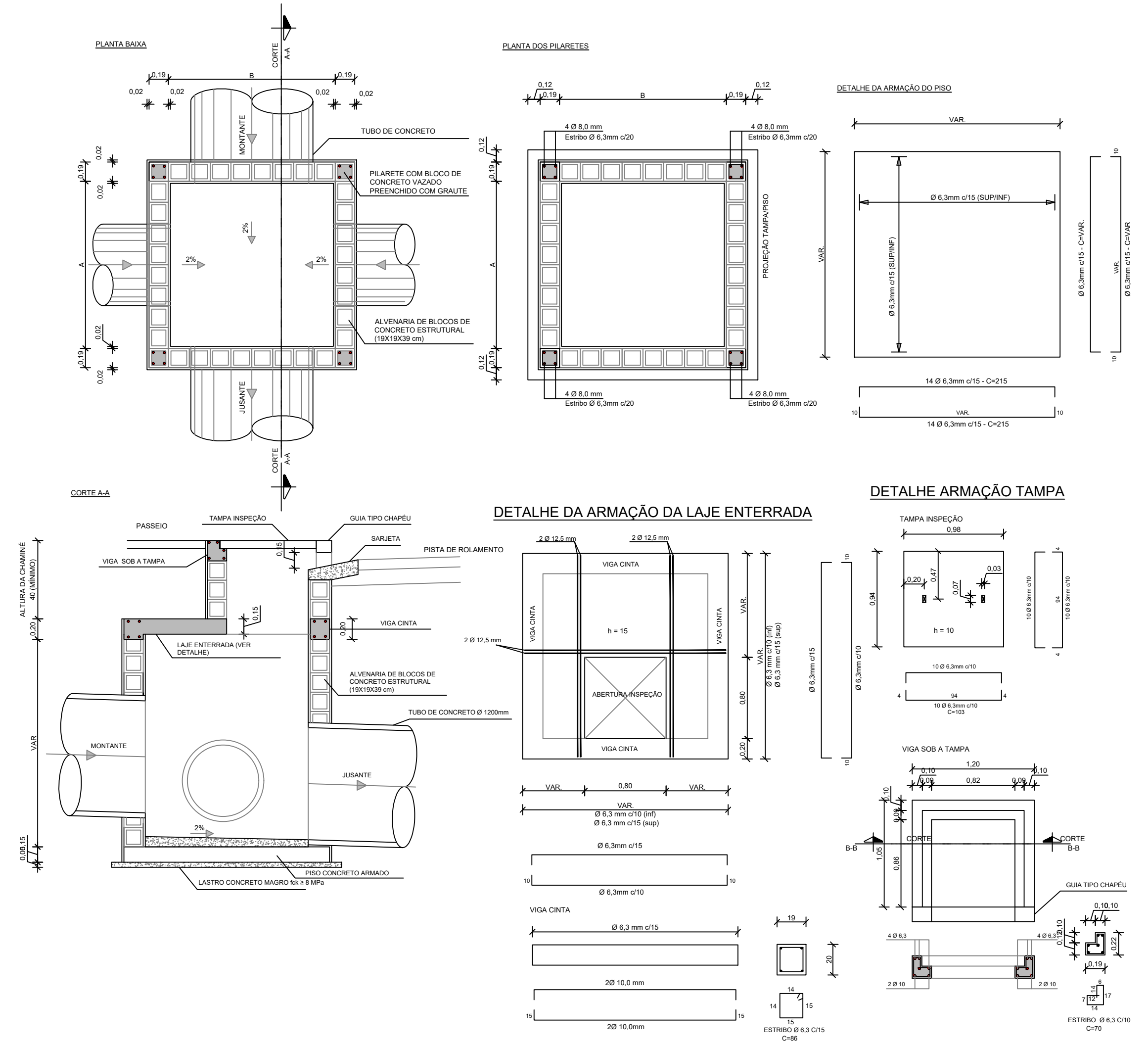

DETALHE DA ARMAÇÃO DA LAJE ENTERRADA

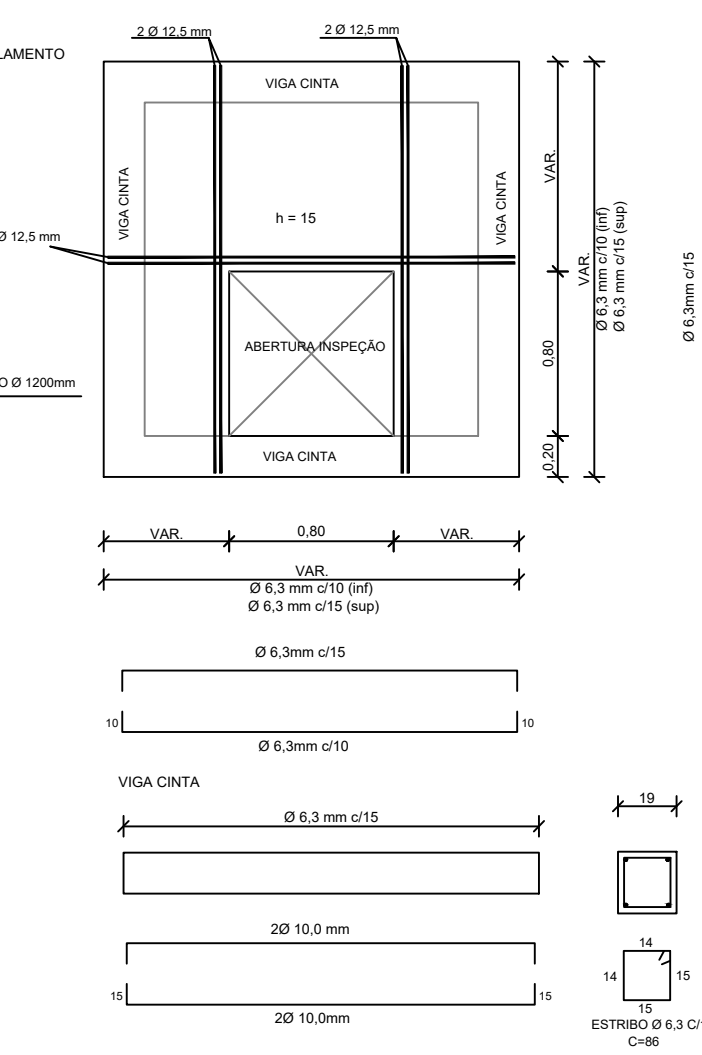

DETALHE ARMAÇÃO TAMPA

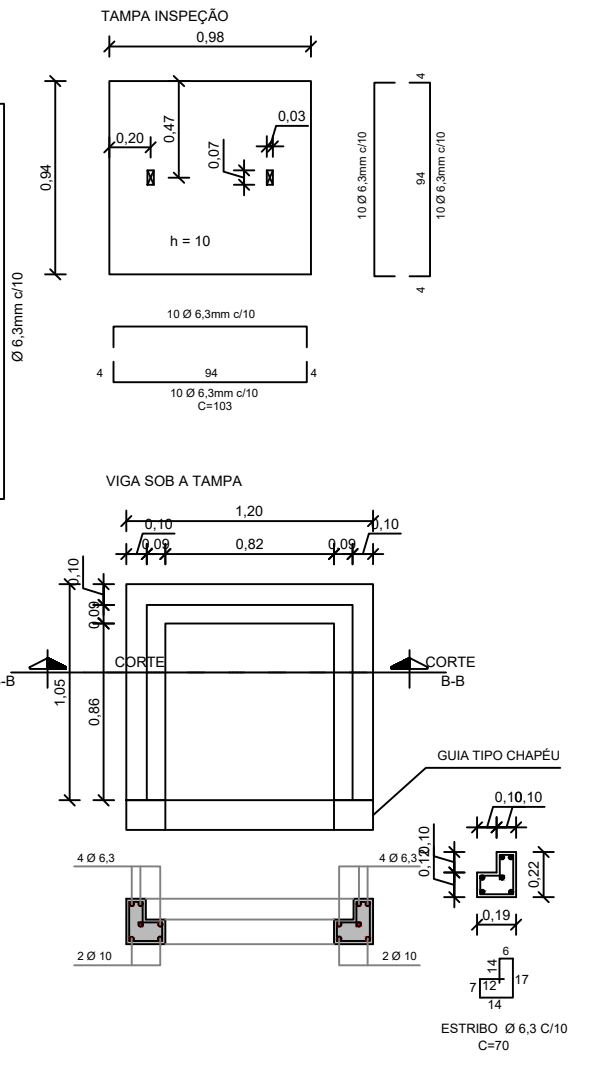

01	Emissão Inicial	06/2022		
REV.	DESCRIÇÃO	DATA	DESENHO	VERIFICADO/APROVADO

**PREFEITURA DE TIMBÓ**  
SECRETARIA MUNICIPAL DE PLANEJAMENTO

Obra: **PRAÇA DA SAÚDE**  
Baixo Pomeranos

Endereço: **RUA POMERANOS X RUA FREDERICO SCHUMANN**

Projeto: **PROJETO DE DRENAGEM**

Resp. Técnico Projeto:

Data: SET/2023	Escala: 1 / 100	Área:	Prancha: DRE. 01/01
----------------	-----------------	-------	---------------------

RUA POMERANOS (SC-110)

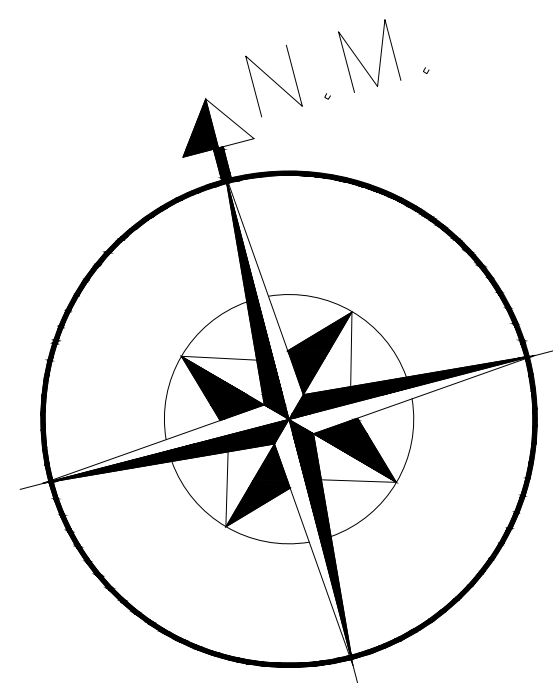

RUA FREDERICO SCHUMANN

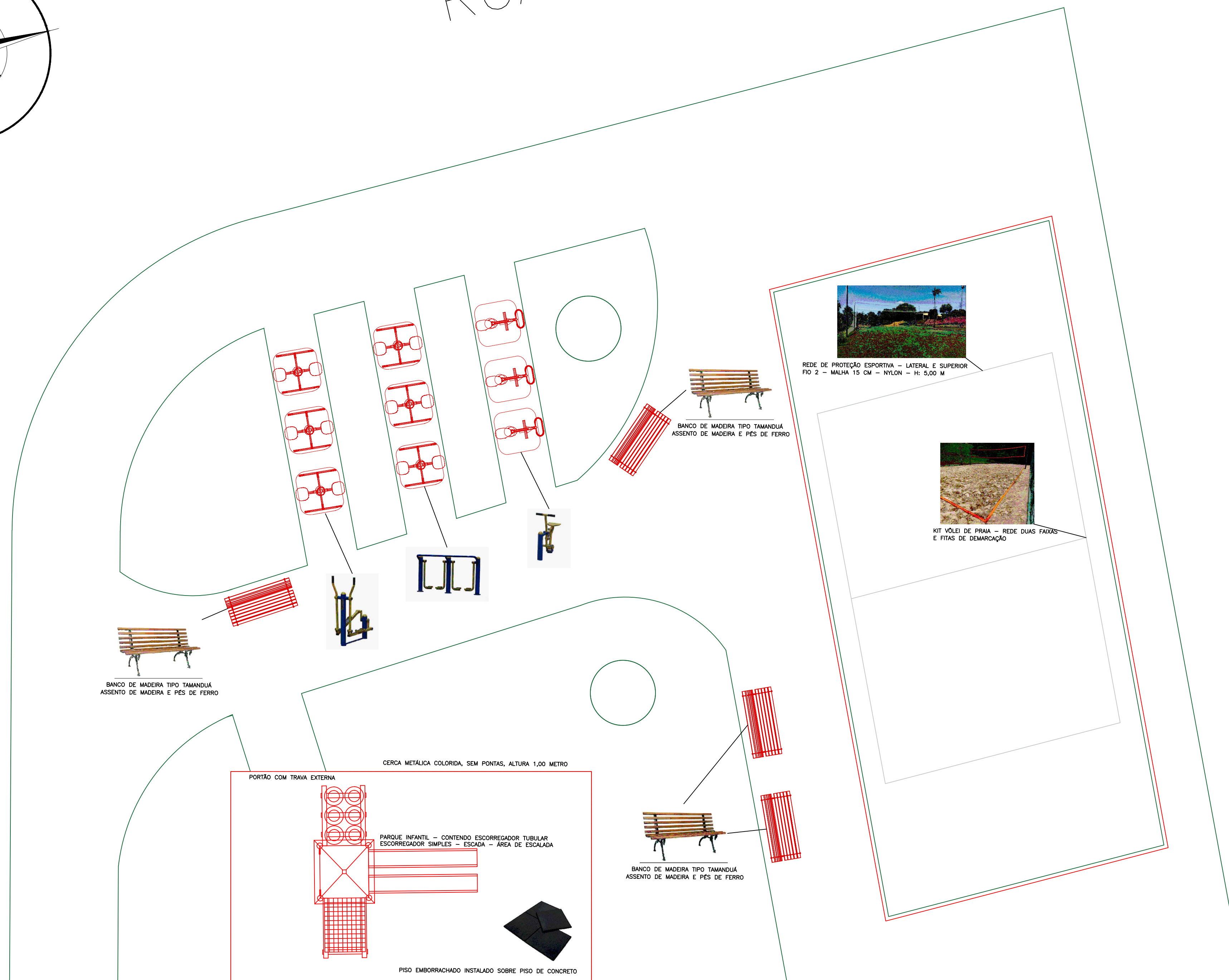

01	Emissão Inicial	06/2022			
REV.	DESCRIÇÃO	DATA	DESENHO	VERIFICADO	APROVADO

**PREFEITURA DE TIMBÓ**  
SECRETARIA MUNICIPAL DE PLANEJAMENTO

Obra: **PRAÇA DA SAÚDE**  
Bairro Pomeranos

Endereço: **RUA POMERANOS X RUA FREDERICO SCHUMANN**

Projeto: **PROJETO - EQUIPAMENTOS**

Resp. Técnico Projeto:

Data:	Escala:	Área:	Prancha:
SET/2023	1 / 75		EQUI. 01/01